

LATI TRADING



LATI TRADING CO LTD

99 101519
99 041096
99 286706
24 669994
latitools@cytanet.com.cy

Your Contact Person:

WWW.LATITOOLS.COM

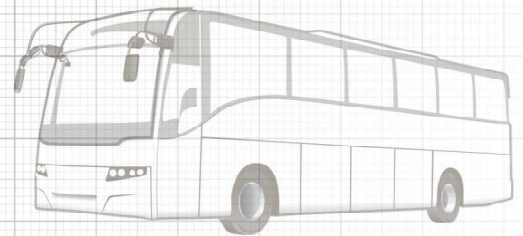
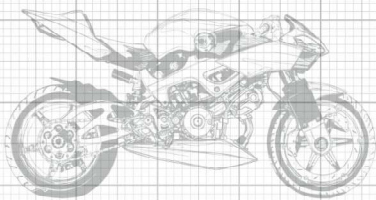
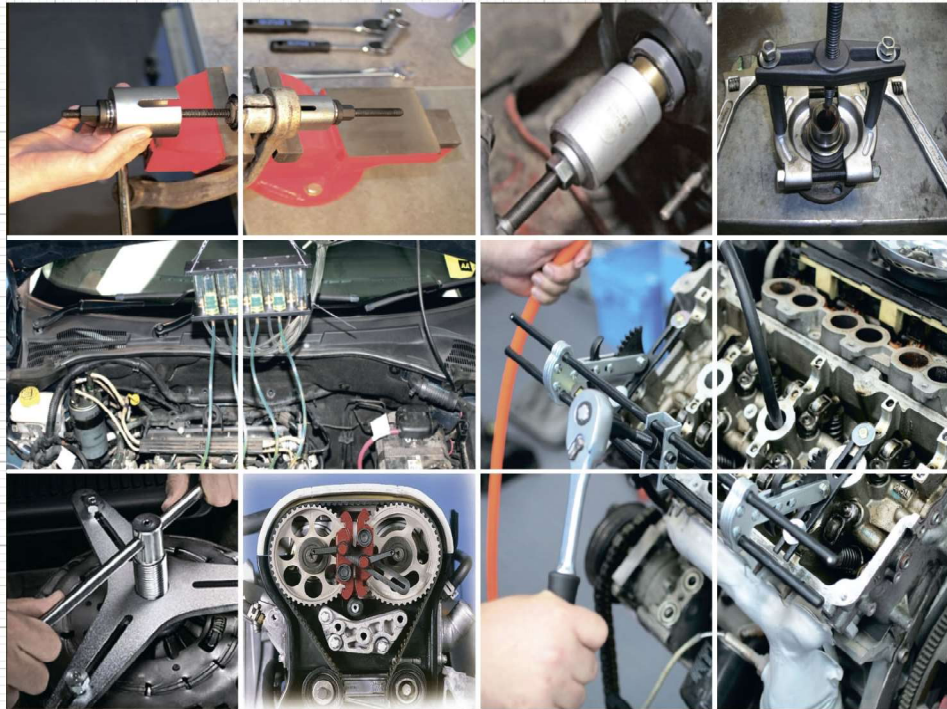
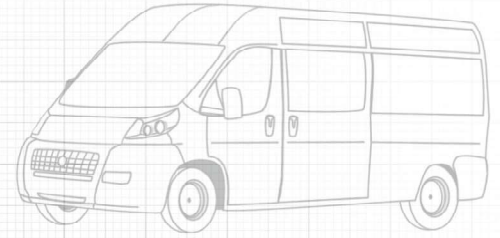
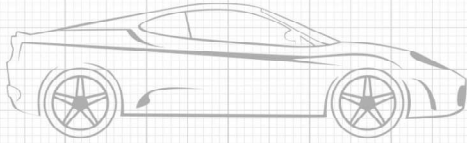

Automotive Collection

BRAKE, CLUTCH AND WHEELS SERVICE TOOLS

Page 02-03

1

PULLERS, STEERING AND SUSPENSION TOOLS

Page 04-07

2

ENGINE REPAIR TOOLS

Page 08-11

3

ENGINE TIMING ADJUSTMENT-LOCKING TOOLS

Page 12-15

4

TESTING AND DIAGNOSTIC TOOLS

Page 16

5

ELECTRICAL AND BATTERY TOOLS

Page 17

6

WRENCH AND SOCKETS SETS

Page 18-21

7

HYDRAULIC LIFTING AND GARAGE EQUIPMENT

Page 22-27

8

GENERAL TOOLS & ACCESSORIES

Page 28-31

9

WORKSHOP STORAGE EQUIPMENT

Page 32

10

BRAKE, CLUTCH, TRANSMISSION AND WHEELS TOOLS

B1861



**CALIPER BRAKE PISTON
REWIND TOOL CASE**
Set includes the latest 3 pin
adapter for new VAG models

ST-24503

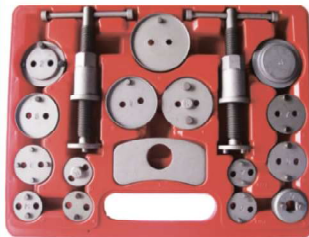

**CALIPER BRAKE PISTON
REWIND TOOL CASE**

B1896



**DISC BRAKE CALIPER
SPREADER**

A8335B



DISC BRAKE CALIPER SPREADER
High precision tool allows easy
function to press-back pistons

ATS-4236



PRESSURE BRAKE BLEEDER PUMP
Capacity: 3.5 L

K3583



VACUUM BRAKE BLEEDER KIT

B9123



**BRAKE CALIPER THREAD
REPAIR KIT** Ideal for repairing the
guide pin threads in the
wheel bearing housing
Thread: M9x1.25mm
Suitable Models: VAG/FORD/OPEL

B9124



**BRAKE CALIPER THREAD
REPAIR KIT**
Ideal for repairing the guide
pin threads in the wheel
bearing housing
Thread: M12x1.5mm

ATC-2264



**HEAVY DUTY DRIVE SHAFT BOOT
CLIPS PRESS TOOL**

KA-5007A



DRIVE SHAFT BOOT CLIPS PLIER

A2506



FLEXIBLE LINE CLAMP PLIER
Ideal for brake, fuel and
vacuum hoses
With automatic clamping
device

HK-2307 Steel Wire
HK-2308 Brass Wire



BRAKE CALIPER BRUSHES

A0192



**BRAKE CALIPER GROOVE
CLEANER**
Universal applications

ATE-4102



**BRAKE CYLINDER HONE
WITH 2 LEGS**
Equipped with replaceable
stones

ST-29008



**BRAKE CYLINDER HONE WITH 3
LEGS**
Equipped with replaceable
stones

A0830



**BRAKE CALIPER GUIDE
BOLT REPAIR SET**
The set includes oversize
guide bolts M10 x 1.25mm
Suitable models:
VAG/FORD/OPEL

BRAKE, CLUTCH, TRANSMISSION AND WHEELS TOOLS

LA-0601



COMPREHENSIVE TOOL SET FOR WHEEL BEARING REMOVAL / INSTALLATION
On the car maintenance

ATC-2237



WHEEL BEARING REMOVAL / INSTALLATION TOOL SET
On the car maintenance

A8674

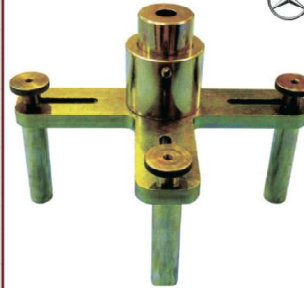

AUTOMATIC TRANSMISSION CLUTCH SPRING COMPRESSOR
OEM code: 208589002100

A3205



AUTOMATIC TRANSMISSION CLUTCH SPRING COMPRESSOR
Universal applications

NP-2110



COMPREHENSIVE CLUTCH ALIGNMENT TOOL SET
Universal applications

MF-0603



CLUTCH ALIGNMENT TOOL SET
Universal applications

A8515



CLUTCH ALIGNMENT TOOL SET FOR TRUCKS
Universal applications

A8723



SAC SELF ADJUSTING CLUTCH ASSEMBLE TOOL
for proper removal and reinstallation as well as centering of self-adjusting 3 hole clutches

A8723A



COMPREHENSIVE SET FOR SAC SELF ADJUSTING CLUTCH ASSEMBLE
For proper removal & reinstallation as well as centering of self-adjusting 3 & 4 hole clutches

ATC-2259A



SAC SELF ADJUSTING CLUTCH CENTERINGS MANDRELS SET

A8348



DSG TRANSMISSION DUAL CLUTCH REMOVAL / INSTALLATION TOOL SET

LA-01735



MOTORCYCLE BRAKE CALIPER PISTON REMOVAL TOOL SET

A849



COMPREHENSIVE SET FOR DSG TRANSMISSION DUAL CLUTCH REMOVAL / INSTALLATION

A849-1



DSG TRANSMISSION ASSEMBLY LEVER FOR MECHATRONIC REMOVAL OEM Code: T10407

A849-2



DSG TRANSMISSION DUAL CLUTCH BEARING GAUGE
OEM Code: T10466

A6361



FREEWHEEL MECHANISM TOOL
Manpower push only, limited to 5 km/h
OEM Code: 164589036300

PULLERS, STEERING AND SUSPENSION TOOLS

A1487



REAR TRAILING ARM BUSHING
REMOVAL / INSTALLATION
TOOL SET Suitable models: E81,
E87, E90, E93, M3

LA-01708



REAR TRAILING ARM BUSHING
REMOVAL / INSTALLATION
TOOL SET Suitable models: E39,
E81, E83, E87, E46, E90, E91, E92,
E93, E60, E66

A8289



REAR TRAILING ARM BUSHING
REMOVAL / INSTALLATION
TOOL SET
Suitable models: E46

ATC-2046



REAR AXLES BUSHING REMOVAL
/ INSTALLATION TOOL SET
Suitable models: E38, E39, E53

MH-1202



DIFFERENTIAL REAR BUSHING
REMOVAL / INSTALLATION TOOL
SET Suitable models: E46, E85

A8281



FRONT CONTROL ARM BUSHING
REMOVAL / INSTALLATION TOOL
SET Suitable models: R50, R53

KB-2107



SUBFRAME BUSHING REMOVAL
/ INSTALLATION TOOL SET
Suitable models: E53

KB-2108



SUBFRAME BUSHING REMOVAL
/ INSTALLATION TOOL SET
Suitable models: E39

ATC-1001



COMPREHENSIVE TOOL SET FOR
BALL JOINTS REMOVAL /
INSTALLATION Suitable
models: W211, W215, W219,
W220, W230, W163, W164

B8677C



BALL JOINTS REMOVAL /
INSTALLATION TOOL SET
Suitable models: W211, W215,
W219, W220, W230

ATC-2204



FRONT CONTROL ARMS
BUSHING REMOVAL /
INSTALLATION TOOL SET
Suitable models: W203, W211,
W220

B9225



COMPREHENSIVE TOOL SET FOR
SUBFRAME BUSHING REMOVAL
/ INSTALLATION
Suitable models: W211

ATC-2266



SUBFRAME BUSHING REMOVAL
/ INSTALLATION TOOL SET
Suitable models: W203

ATC-2287



SUBFRAME BUSHING REMOVAL
/ INSTALLATION TOOL SET
Suitable models: W210

ATC-2054



REAR AXLES BUSHING REMOVAL
/ INSTALLATION TOOL SET
Suitable models: W140, W124,
W201, W202, W203, W208,
W209, W210

ATC-2054B



DIFFERENTIAL FRONT BUSHING
REMOVAL / INSTALLATION
TOOL SET Suitable models:
W203, W210

PULLERS, STEERING AND SUSPENSION TOOLS

LA-01585



FRONT CONTROL ARMS BUSHING REMOVAL / INSTALLATION TOOL SET
Suitable models: W203, W211, W220, E39, E60, E65, E66

ATC-2158C



MACPHERSON TYPE STRUT COIL SPRING COMPRESSOR KIT
 Exchangeable clamping plates with plastic coated jaws

ATC-2157



COIL SPRING COMPRESSOR KIT
Suitable models: W140, W124, W201, W202, W208, W210

B2257



MACPHERSON TYPE STRUT INSERT PISTONS SPECIAL CLAMP KIT
Suitable models: W203, E46, E39 etc.

ATC-2163



COIL SPRING COMPRESSOR KIT EXTRA LONG
 Set Includes 300mm and 400mm screws

BSD-1101



HYDRAULIC PULL AND PRESS SLEEVE KIT
 Ideal for removal and installation of all kind of bearings and bushings
 Hydraulic capacity 18 tons

MD-0901



UNIVERSAL BEARING AND BUSHING SERVICE KIT

LA-E3523



UNIVERSAL BEARING AND BUSHING SERVICE KIT

ATC2158-14



SPECIAL JAW FOR STRUT COIL SPRING REPLACED Suitable models: BMW E39 & E46

B19672A



BALL JOINT EXTRACTOR SET
 Sizes: 23, 28, 34mm

B1969F



HYDRAULIC HGV BALL JOINTS SEPERATOR

B1959



BALL JOINT PULLER
 2-step adjustable, for pressing out the ball joints

M1970



INNER BEARING EXTRACTOR SET

B1417

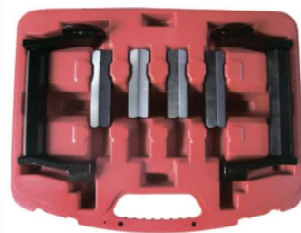

WHEEL ALIGNMENT TOOL KIT FOR PROFESSIONALS

B1397 DIAM.: 42-50mm
 B1397A DIAM.: 33-42mm



MULTI PURPOSE INNER TIE ROD TOOLS

B1398 DIAM.: 33-42mm



MULTI PURPOSE INNER TIE ROD TOOL

PULLERS, STEERING AND SUSPENSION TOOLS

ST-24514



UNIVERSAL AXLES SLIDE HAMMER PULLER KIT

ATB-1097

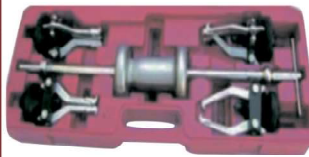

INTERNAL & EXTERNAL SLIDE HAMMER PULLER KIT

ATB-1064



UNIVERSAL BEARINGS PULLER TOOL KIT

For removing bearings, interior rings & other tightly fixed parts

GG-2930

12T



HYDRAULIC SPINDLE AND WHEEL HUB PULLER KIT

Universal use for nearly all cars with 4 and 5 holes hub
High power efficiency
Hydraulic capacity 12 tons

ATB-1141



UNIVERSAL PULLER SET

3 sizes arms can be used as inner and outer puller.
Ideal for transmission overhaul

ATA-1074

10T



HYDRAULIC SPINDLE SEPERATOR KIT FOR BEARINGS AND AXLES

ATC-2025



BALL JOINTS REMOVAL / INSTALLATION TOOL SET

ATC-2092



UPPER SUSPENSION ARMS BUSHING REMOVAL / INSTALLATION TOOL SET

LA-01815



SPECIAL EXTRACTOR SET FOR REMOVING PULLEYS

ATB-1140



SPECIAL EXTRACTOR SET FOR REMOVING PULLEYS IN 2 SIZES

LA-E3525



WHEEL HUB / WHEEL BEARING TOOL KIT

Suitable for vehicles with 62mm, 66mm and 72mm wheel hub

UI-7P



UNIVERSAL PULLER SET FOR DRIVE SHAFTS

ATB-1038 CAP.:50-75mm

ATB-1039 CAP.:75-105mm

ATB-1040 CAP.:105-150mm

ATB-1041 CAP.:150-200mm



UNIVERSAL BEARING SEPERATORS

ATB-1025B CAP.:130x100mm

ATB-1025D CAP.:200x150mm

ATB-1025F CAP.:350x200mm



UNIVERSAL TWIN ARM PULLERS

ATB-1018A CAP.:76-102mm

ATB-1018B CAP.:76-178mm



GEAR PULLER WITH AUTOGRIP

ATB-1186



EXTRACTOR FOR REMOVING RIBBED DRIVE PULLEYS

PULLERS, STEERING AND SUSPENSION TOOLS

ATG-5003



SPECIAL VIPRO CHISEL SET
Vibration has a strong rust removing effect, loosening successfully any stuck screw

ATC-2180



HYDRAULIC SPINDLE PRESS TOOL KIT Ideal for removal / installation of ball joints on commercial vehicles

PE-1813



ADAPTORS KIT FOR SUSPENSION WISHBONE BALL JOINTS
Specifically for: SPRINTER 901, 902, 903, 904 (1995-on) & VW LT

KD-0305



ADAPTORS KIT FOR SUSPENSION WISHBONE UPPER AND LOWER BALL JOINTS
Specifically for: RENAULT MASTER DC2 and VAUXHALL / OPEL MOVANO

HM-1106



WHEEL HUB / WHEEL BEARING TOOL KIT Suitable for vehicles with 72mm wheel hub

KA-0502



FRONT WISHBONE BRACKET BUSHING REMOVAL / INSTALLER TOOL KIT
Suitable vehicles: VW POLO (9N), SEAT IBIZA, CORDOBA, SCODA FABIA

KA-0407



UNIVERSAL STEERING AND KNUCKLE SPREADING TOOL KIT
For: VAG, BMW, CITROEN, FORD, PEUGEOT, RENAULT

BYF-6380



REAR AXLES BUSHING REMOVAL / INSTALLATION TOOL SET Suitable vehicles: AUDI A3, VW BORA, GOLF IV

KB-1001



FRONT WISHBONE BUSH INSTALLER Suitable vehicles: VW POLO (2002-), SEAT IBIZA, SCODA FABIA

A978



PULLER FOR WHEEL BEARING INNER RACE

ATA-0365 Cap: 11 - 15mm
M1979 Cap: 5.5 - 8mm



BEARING EXTRACTOR TOOL SET

ATA-0198



INNER BEARING PULLER SET

HD-2021



UNIVERSAL WIPER ARM PULLER
Allows trouble free disassembly of all current wiper arms

A1548



GEAR PULLER WITH THIN JAWS
Ideal for crankshaft timing gears

QK-1130A



DRIVE SHAFTS RETHRADING TOOL SET

B1961



UNIVERSAL BALL JOINT SEPERATOR

A624350



COMPREHENSIVE TOOL SET FOR OVERHEAD CAM VALVE SPRING COMPRESSOR
Suitable for wide range of new vehicle applications

A2045



NEW DESIGN UNIVERSAL OVERHEAD CAM VALVE SPRING COMPRESSOR SET
Ideal for V6 & V8 engines

A1238



UNIVERSAL OVERHEAD CAM VALVE SPRING COMPRESSOR SET

A2014



UNIVERSAL OVERHEAD CAM VALVE SPRING COMPRESSOR SET Suitable for older petrol and diesel engines

A2050



UNIVERSAL OVERHEAD CAM VALVE SPRING COMPRESSOR SET
Suitable for petrol engines only

A8808



BMW VALVE PRESSURE SPRING INSTALLER / REMOVER
Suitable engines: N20, N26, N55
OEM code: 117110

A3521



VALVE GUIDES SEALS REMOVAL / INSTALLATION TOOL SET

ATA-0018



VALVE SPRING COMPRESSOR
Universal application for diesel and petrol engines

LA-01644  



BENZ & BMW Fan Clutch Service Kit

A911528 



ASSORTMENT OF TOOLS FOR REMOVING BROKEN GLOW PLUGS Glow plug sizes: M8-M9-M10 x 1.0mm

PN-1104  



ASSORTMENT OF TOOLS FOR REMOVING BROKEN GLOW PLUGS for 2.5/2.7/3.0 V6 TDI
Glow plug sizes: M10x1.0mm

KN-0103 



ASSORTMENT OF TOOLS FOR REMOVING BROKEN GLOW PLUGS
Glow plug sizes: M8-M10 x 1.0mm

MM-0309 



ASSORTMENT OF TOOLS FOR REMOVING BROKEN GLOW PLUGS
Glow plug sizes: M8 x 1.0mm

PE-0612



IMPACT GLOW PLUGS REMOVAL TOOL SET
Universal applications

UI-PR3 



GLOW PLUGS PULLER AND REAMER KIT Suitable engines: 604, 605, 606, 611, 612, 613

HK-2317D



MASTER UNIVERSAL INJECTOR SEALING CLEANING & MILLING TOOL SET For damage-free and professional application

LA-01765



UNIVERSAL INJECTOR SEALING CLEANING & MILLING TOOL SET
Cleans injector seats and chambers when changing or reconditioning diesel injectors

LA-01388



MASTER UNIVERSAL DIESEL INJECTOR REMOVAL & DISMANTLING TOOL SET Ideal for Bosch, Delphi, Denso and Siemens injectors

A8251



DIESEL INJECTOR REMOVAL & DISMANTLING TOOL SET
Suitable engines: 611, 612, 613, etc.

A8779



HEAVY DUTY SLIDE HAMMER INJECTOR REMOVER KIT
Ideal for Bosch, Delphi, Denso and Siemens injectors. Set includes flexible u-joint adaptor for access in restricted area

A8780



DIESEL INJECTOR REMOVAL & DISMANTLING TOOL SET
Set includes a huge range of adaptors and claws covering a wide range of new vehicle applications

A8709



DIESEL INJECTOR PULLER
Suitable engine: OM642 with Delphi injectors

A2621



DIESEL INJECTOR REMOVAL & DISMANTLING TOOL SET
Suitable engines: M47 & M57

A8019



DIESEL INJECTOR REMOVAL TOOL SET
Suitable engine: OM668

KN-0102



DIESEL INJECTOR REMOVAL & DISMANTLING TOOL SET
Suitable engines: 2.0HDI / JTD

A8716



IMPACT DIESEL INJECTOR REMOVAL TOOL SET
Suitable engines: 611, 612, 613, etc.

UI-IPS3PCS

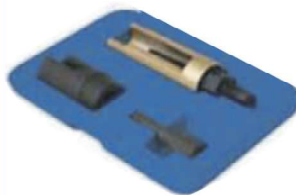

DIESEL INJECTOR REMOVAL & DISMANTLING TOOL SET
Suitable engines: 611, 612, 613, etc.

ATA-2118



INJECTOR PULLER SET WITH SLIDE HAMMER
Suitable for: VAG FSI engines

ATA-4417



FLYWHEEL HOLDER TOOL SET
Holds flywheel when loosening and tightening center crankshaft bolt
Suitable engines: M47, M57, M67, N45, N46, N51 & N52
OEM code: 118180

A8083A



CRANKSHAFT PULLEY HOLDER
Holds vibration damper when loosening and tightening center crankshaft bolt
Suitable engines: M47 & M57

A0009M



INJECTOR PULLER
Suitable engines: M271 (after 2007)
OEM code: 271589023300

A0031



INJECTOR PULLER WITH SLIDE HAMMER
Suitable engines: N43, N53 & N54
OEM code: 130180

A8621



CRANKSHAFT PULLEY HOLDER
Holds vibration damper when loosening and tightening center crankshaft bolt
Suitable engines: M112 & M113

ATA-0165



CRANKSHAFT PULLEY HOLDER
Holds vibration damper when loosening and tightening center crankshaft bolt
Suitable engines: M271

ST-24004



CUP TYPE OIL FILTER WRENCH MASTER KIT

A2131



CUP TYPE OIL FILTER WRENCH KIT
Set covers a huge range of new vehicles

A2008 $\frac{1}{2}$



21pcs OIL DRAIN PLUG KEY SET
Universal applications

A2663 $\frac{3}{8}$



5pcs OIL FILTERS WRENCH SET
Sizes: 24, 27, 32, 36 & 38mm
Universal applications

ATA-0262 $\frac{1}{2}$ $\frac{3}{8}$



STRAP TYPE OIL FILTER WRENCH DUAL DRIVE

ATA-0265



STRAP TYPE OIL FILTER WRENCH
Size: 25 - 160mm

ATA-0418E



OIL FILTER CUP WRENCH
Size: 84mm x 14 flats
Suitable engine: OM642

A2089



ADJUSTABLE OIL FILTER REMOVER WITH 3 LEGS

LA-01620



WATER PUMP REMOVAL KIT For VW T5 & TOUAREG 2.STDi
Suitable engines:
AXD, AXE, BAC, BLJ, BLK, BNZ, BPC, BPD

ST-24548A CAP: 60-90mm
ST-24548B CAP: 85-115mm



OIL FILTER PLIERS

HJ-1211



OIL FILTER CUP WRENCH
Size: 74mm x 14 flats

A6822



OIL SERVICE WRENCH
Size: 8 & 10mm

ST-23051

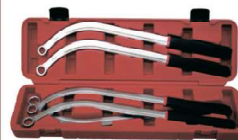

5 PCS DAMPER PULLEY HOLDER WRENCH SET

A8318-1



CRANKSHAFT PULLEY HOLDER Holds vibration damper when loosening and tightening center crankshaft bolt.
Suitable engines: VAG 1.8L & 2.0L TFSI / TSI 2008→
OEM code: T10355

ST-23004



UNIVERSAL PULLEY HOLDER
Ideal tool set for locking turning and holding of perforated pulleys

A1739

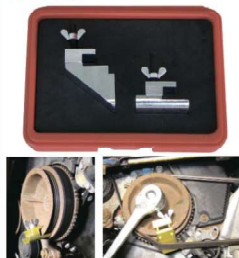

TOOL KIT FOR ELASTIC - RIBBED BELTS
Universal applications

A1739B



TOOL KIT FOR ELASTIC - RIBBED BELTS
Universal applications

A1574



SERPENTINE BELT TOOL
Suitable models: BMW - MINI W10/W11 1600cc engines as used in the MINI ONE/ COOPER / COOPER 'S

ATA-2039



2pcs CAMSHAFT ADJUSTMENT TOOLS FOR VAG 1.8 & 2.0 TSI / TFSI ENGINES
OEM code: T10351 & T10352

B7017



OIL SEAL INSTALLER TOOL KIT
For damage-free and professional application

KG-0303



OIL SEAL REMOVAL & INSTALLER TOOL KIT
Universal applications

A8268



CRANKSHAFT REAR OIL SEAL REMOVAL & INSTALLER TOOL KIT
Suitable engines: N40, N42, N45, N46, N52, N53, N54

A5014



CRANKSHAFT AND CAMSHAFT OIL SEAL REMOVAL KIT
Suitable for: oil seals with 32 & 55mm diameter

ATA-4205



CRANKSHAFT REAR OIL SEAL INSTALLER TOOL KIT
Suitable engines:
M271 & M272
For damage-free and professional application

ATA-2023



CRANKSHAFT REAR OIL SEAL INSTALLER TOOL KIT
For damage-free and professional application
OEM code: T10017

ATA-2601



CRANKSHAFT REAR OIL SEAL INSTALLER TOOL KIT
For damage-free and professional application
OEM code: T10134

PD-1104



TIMING CHAIN RIVETING TOOL KIT
This special tool kit allows quick, easy and safe reconnection of the timing chains
Kit covers a huge range of new engines

A2532



OXYGEN SENSOR THREADS REPAIR TOOL SET
Sizes: M18 x 1.5mm
Universal applications

A1566



UNIVERSAL CAMSHAFT SPROCKET PULLER

LA-01882



UNIVERSAL PULLEY HOLDER

LA-01845



FLYWHEEL PULLER SET
Set covers a huge range of motorcycles

ST-23011



DELUXE A/C COMPRESSOR CLUTCH HUB PULLER / INSTALLER

ATA-0080



TORQUE ANGLE GAUGE

ST-23033A



PISTON RING COMPRESSOR WITH STEP LESS ADJUSTMENT

A3327



VALVE GUIDES SEALS REMOVAL PLIER

A8663



TIMING CHAIN GUIDE RAIL PIN PULLER

A8713



POWER BAR HAND IMPACT WRENCH
Special tool for removing crankshaft pulleys screws

ENGINE TIMING ADJUSTMENT – LOCKING TOOLS

A8806

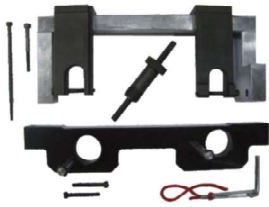

TIMING TOOL SET
for BMW N20 & N26
engines

A8287



TIMING TOOL SET
for BMW N47 & N57
engines

A8807



TIMING TOOL SET
for BMW-MINI N13 & N18
engines

ATA-2031



TIMING TOOL SET
for BMW N43 engines

ATA-2012



TIMING TOOL SET
for BMW N51, N52, N53 & N54
engines

ATA-2010



TIMING TOOL SET
for BMW N40 & N45
engines

A1762



TIMING TOOL SET
for BMW-MINI N12 & N14
engines
Also for CITROEN & PEUGEOT

ATA-0381



DOUBLE VANOUS SET UP
for BMW M52, M54 & M56
engines

A1692



MASTER TIMING TOOL SET
for BMW N42 & N46
engines

A1691

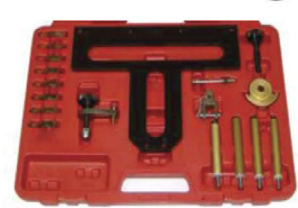

**CAMSHAFTS CARRIER
REMOVAL / INSTALLER TOOL
SET** for BMW N42 & N46
engines

A1689



TIMING TOOL SET
for BMW N42 & N46
engines

ATA-0427



DOUBLE VANOUS SET UP
for BMW M42, M44, M50,
M52, M54 & M56 engines

MH-1201



**BALANCE SHAFT
LOCKING TOOL**
for BMW N40, N42, N45
& N46 engines

ATA-0515A



**DIESEL INJECTION
PUMP REMOVER AND
SPROCKET RETAINER**
for BMW M47 & M57
engines

A8287-1



**DIESEL INJECTION PUMP
REMOVER AND SPROCKET
RETAINER** for BMW N47 &
N57 engines

A8665



TIMING TOOL SET
for BMW M40, M43,
M70 & M73 engines

A8664



TIMING TOOL SET
for BMW M41 & M51
engines

ENGINE TIMING ADJUSTMENT – LOCKING TOOLS

A1759



TIMING TOOL SET
for BMW M47 & M57 engines

A1694



TIMING TOOL SET
for BMW-MINI W10B16AA,
W10B16BA & W11B16AA
engines

A8359



TIMING TOOL SET
for FORD 1.0 SCTi TURBO
ECOBOOST
3-cylinders engines

A8810



TIMING TOOL SET
for VOLVO V4 1.6L & 2.0L
T4 & T5 ENGINES 2010 →

A8202



TIMING TOOL SET
for FORD 1.6 SCTi / Ti-
VCT ECOBOOST direct
injection engines 2010 →

A1619



**TIMING TOOL SET
AND DIESEL PUMP REMOVER**
for FORD TRANSIT 2.0
& 2.4 TDDi / TDCi
engines 2001 →

A1683



TIMING TOOL SET
for FORD 1.2 through 2.0
DURATEC twin cam engines

A1537



TIMING TOOL SET
for VOLVO with 4,5 & 6
cylinders twin cam engines
until 2006

A1764



TIMING TOOL SET
for FORD 1.2 through 2.0
DURATEC petrol engines
Also for 1.8 & 2.0TDDi /
TDCi diesel engines

A1618



TIMING TOOL SET
for OPEL / VAUXHALL
1.3CDTi engines

A1646



TIMING TOOL SET
for OPEL / VAUXHALL
1.9CDTi engines

A1781



TIMING TOOL SET
for OPEL / VAUXHALL
1.0, 1.2 & 1.4 with chain
driver engines

A1820



TIMING TOOL SET
for OPEL / VAUXHALL
2.0CDTi engines

A8261



TIMING TOOL SET
for OPEL / VAUXHALL
1.6 & 1.8 with twin port
inlet and variable timing
engines

A8299



TIMING TOOL SET
for OPEL / VAUXHALL
1.0, 1.2 & 1.4 with chain
driven engines 2010 →

A1672



MASTER TIMING TOOL SET
for OPEL / VAUXHALL
petrol and diesel engines
until 2009

ENGINE TIMING ADJUSTMENT – LOCKING TOOLS

ATA-4012



TIMING TOOL SET
for VAG 2.7, 3.0, 4.0 & 4.2
V6 / V8 TDI engines

LA-01695



TIMING TOOL SET
for VAG 2.5 & 4.9 TDI PD
engines

A8254



TIMING TOOL SET
for VAG 1.4 & 1.6 FSi
/ TSi engines

A8819

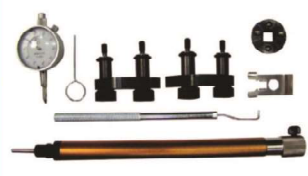

TIMING TOOL SET
for VAG 1.8 & 2.0 TFSI
/ TSi engines

LA-01173

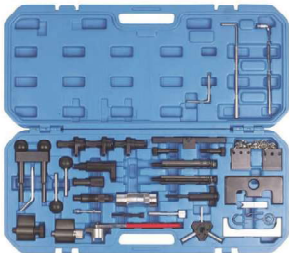

MASTER TIMING TOOL SET
for VAG petrol and diesel
engines until 2008

A1809



TIMING TOOL SET
for VAG 1.6 & 2.0 TDI
CR 5th generation blue
motion engines

A1719



TIMING TOOL SET
for VAG 2.0 FSi engines

A8318



TIMING TOOL SET
for VAG 2.0 TSI
(CAEB) TURBOCHARGED
engine 2008→

A780

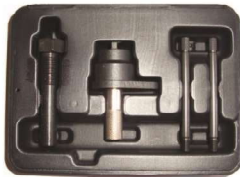

TIMING TOOL SET
for VAG 1.2 TSi engines

A1793



TIMING TOOL SET
for VAG 1.4 & 1.6 FSi /
TSi engines

A1651



TIMING TOOL SET
for VAG 1.2 (6/12 valves)
3 cylinders engines

FB-2846



TIMING TOOL SET
for VAG 2.4 & 3.2 FSi
engines

A1727



**Special kit for Bosch
EP/VE Rotary timing
adjustment**

A1631



CAMSHAFT LOCKING TOOL
for VAG 1.4 & 1.6 engines

A1663



TIMING TOOL SET
for VAG 2.0TDi PD twin
cam engines

A8342



TIMING TOOL SET
for VAG 1.0 MPi VVT
3 cylinder engine 2012 →

A1697



**TIMING BELT TENSIONER
DOUBLE-PIN WRENCHES SET**
for VAG engines

A1701



**Special kit for Bosch
EP/VE Rotary, Kikki,
Nippon Denso, Cav
Rotodiesel timing
adjustment**

ENGINE TIMING ADJUSTMENT – LOCKING TOOLS

FB-2848



MASTER TIMING TOOL SET
for RENAULT petrol and diesel engines until 2010

FB-2859



TIMING TOOL SET
for RENAULT 2.0 DCi chain driven engines

A1647



TIMING TOOL SET
for RENAULT 1.5, 1.9, 2.2 & 2.5 DCi engines

A1789



TIMING TOOL SET
for RENAULT 1.4, 1.6, 1.8 belt driven engines

A1695



TIMING TOOL SET
for RENAULT 2.0 IDE (F5R) engine

A8782



DIESEL INJECTION PUMP PULLEY LOCKING TOOL
for RENAULT 1.9DCi (F9Q) engine

FB-2723



TIMING TOOL SET
for FIAT 1.3CDTi engine

FB-2735



TIMING TOOL SET
for FIAT 1.2 16-valve engine

A8280



TIMING TOOL SET
for FIAT 0.9 TWIN AIR engine 2010 →

A1678



CAMSHAFT LOCKING TOOL SET for ALFA ROMEO 1.4, 1.6, 1.8 & 2.0 engines

A1720



TIMING TOOL SET
for FIAT / IVECO 2.3 & 3.0JTD engines

LA-01243



TIMING TOOL SET
For FIAT 1.6 16-valve engine

LA-01498



TIMING TOOL SET
for FIAT 1.2 & 1.4 8-valve engines

LA-01513



CAMSHAFT LOCKING TOOL and TIMING CHAIN RETAINER for BENZ M271 engine

LA-01749



CAMSHAFT LOCKING TOOL SET for BENZ M270 engine

A8802



CAMSHAFT LOCKING TOOL SET for BENZ M651 engine

A1513



UNIVERSAL TIMING BELT SPROCKET LOCKING TOOL

LA-01022



TIMING TOOL SET for LAND ROVER 200tdi, 300tdi, 2.5D/ 2.5TD diesel engines

G3729C



UNIVERSAL RADIATOR PRESSURE TESTER & VACCUUM PURGE MASTER KIT
Suitable for wide range of vehicle applications

A4503



VACCUUM AND PRESSURE TESTING KIT
Set includes flexible hose and various couplings

AT-135A



FUEL FLOW METER KIT FOR COMMON RAIL INJECTORS
Quick and effective measure of the fuel flowing back
Suitable for use on Bosch, Denso, Siemens and Delphi diesel injectors

A1208



FUEL FLOW METER KIT FOR COMMON RAIL INJECTORS
Quick and effective measure of the fuel flowing back
Suitable for use on Bosch, Denso, Siemens and Delphi diesel injectors

G3729-1



UNIVERSAL HAND OPERATED PRESSURE PUMP

A1209



CYLINDER PRESSURE LEAK TESTER & CRANK STOPPER KIT
To check the tightness of petrol engine cylinders

B1209



MASTER CYLINDER PRESSURE LEAK TESTER AND CRANK STOPPER KIT
To check the tightness of petrol engine cylinders

EM-1009



FUEL RETURN FLOW PRESSURE TESTING KIT FOR COMMON RAIL ENGINES

AT-145I



MASTER COMPRESSION TESTER KIT FOR DIESEL ENGINES
Universal adapters for glow plugs and injectors
Suitable for wide range of vehicle applications

AT-050



FUEL INJECTION PRESSURE TESTER KIT
Universal kit with precision gauges
Suitable for wide range of vehicle applications

AT-110



COMPRESSION TESTER KIT FOR DIESEL ENGINES
Universal adapters for glow plugs and injectors

AT-120



OIL PRESSURE TESTER KIT
Suitable for wide range of vehicle applications

A1211



COMPRESSION TESTER KIT FOR PETROL ENGINES
Quick release connection system

LA-01059



COMPRESSION TESTER KIT FOR PETROL ENGINES

A1406



TURBO SYSTEM TESTING ADAPTORS KIT
Professional and easy fault diagnosis

G3810



CO2 CYLINDER LEAKAGE TESTING KIT
To locate leaks on internal combustion engines

A0919W



UNIVERSAL RADIATOR PRESSURE TESTER FOR HEAVY DUTY TRUCKS

ST-25001



RADIO REMOVAL TOOL SET
For all major car radios and navigation systems

LA-01404



COMBINED SOCKETS FOR ALTERNATOR FREEWHEEL PULLEY REPAIR KIT

A8601



AIR BAG TOOL SET
For disassembling the air bag unit and assembly / disassembly of the airbag cushion

N6124



LED RECHARGEABLE INSPECTION LAMP
2 functions with 36 Super bright LED bulbs

N1023



MULTIMETER CASE WITH MULTI PURPOSE CONNECTORS
Ideal set for automotive diagnostic solution

YF-62283



IGNITION COILS REMOVER SET FOR VAG VEHICLES
For damage free removal of ignition coils

N3181



PROFESSIONAL DIGITAL AUTOMOTIVE MULTIMETER

A00061



IGNITION COILS REMOVER FOR VAG VEHICLES 2013 →
For damage free removal of ignition coils

N2052



PROFESSIONAL CIRCUIT TESTER 6, 12 & 24 VOLTS

N2064



PROFESSIONAL CIRCUIT LED TESTER 12 & 42 VOLTS

ATP-2030



PROFESSIONAL CIRCUIT TESTER 6-24 VOLTS
Ideal for energizing electrical components

N2061A



BRAKE FLUID TESTER
Electronic, for testing the percentage of water in brake fluid

E1002A



240pcs MICRO & MEGA BLADE FUSE SET FROM 3A-30A

E2027



530pcs AUTOMOTIVE TERMINALS CONNECTOR SET

E1003A



105pcs MINI BLADE FUSE SET FROM 5A-30A
Ideal for new Japanese models

KA-3569



DIAGNOSTIC IGNITION SPARK PLUG CABLE
Provides instant diagnosis of ignition problems

ALK-6003F $\frac{3}{4}$ "



21pcs $\frac{3}{4}$ " SOCKET SET
Sizes: 19-50mm

ALK-8009F $\frac{1}{4}$ " $\frac{1}{2}$ "



143pcs $\frac{1}{4}$ " + $\frac{1}{2}$ " SOCKET SET

ALK-8006F $\frac{1}{4}$ " $\frac{3}{8}$ " $\frac{1}{2}$ "



120pcs $\frac{1}{4}$ ", $\frac{3}{8}$ " + $\frac{1}{2}$ "
COMPLETO SOCKET SET

ALK-8001F $\frac{1}{2}$ "



25pcs $\frac{1}{2}$ " SOCKET SET

AWT-ERSK04



18pcs COMBINATION
SPANNER SET
Sizes: 7-32mm

AWT-ERSK03 SAE



14pcs COMBINATION SAE
SPANNER SET $\frac{5}{16}$ " - $1\frac{1}{4}$ "

AWT-EKFK02



12pcs DOUBLE OFF. RING
SPANNER SET
Sizes: 6-32mm

AWT-EDSK01



12pcs DOUBLE OPEN END
SPANNER SET
Sizes: 6-32mm

ARW-50MK01



5pcs FLEXIBLE STUBBY
RATCHET SPANNER SET
Sizes: 8, 10, 12, 13 + 15mm

AWT-ADMK01



9pcs COMBINATION
STUBBY SPANNER SET
Sizes: 10-19mm

AWT-FXFK01



4pcs FLEXIBLE FLARE NUT
WRENCH SET
Sizes: 8, 10, 11 + 12mm

ACK-274002 $\frac{1}{4}$ "



47pcs $\frac{1}{4}$ " SOCKETS
AND BITS SET

LA-13011 $\frac{1}{4}$ "



46pcs $\frac{1}{4}$ " SOCKETS
AND BITS SET

ACK-274004 $\frac{1}{2}$ "



19pcs $\frac{1}{2}$ " TORX SOCKETS
AND BITS SET
Sizes: E10-E24, T20-T70

ACK-274011



6pcs COMBINATION E-TORX
WRENCH SET E6-E24

A1439 16mm Joint Socket

A1489 14mm Socket

ATF-4005 14mm Long Socket

ATF-4006C 16mm Socket



SPARK PLUGS SOCKETS

A0749 $\frac{1}{2}$ "



8pcs $\frac{1}{2}$ " SPECIAL SOCKETS SET
FOR DIESEL INJECTOR PIPE LINE
FITTINGS
Sizes: 12-19mm

ASA-80007 — 1"



9pcs 1" IMPACT DEEP SOCKET SET
Sizes: 24-50mm

ASA-80005 — 1"



9pcs 1" IMPACT SOCKET SET
Sizes: 24-50mm

ASA-60007 — 3/4"



8pcs 3/4" IMPACT DEEP SOCKET SET
Sizes: 26-38mm

ASA-60005 — 3/4"



8pcs 3/4" IMPACT SOCKET SET
Sizes: 26-38mm

ASA-40001 — 1/2"



8pcs 1/2" HEX IMPACT SOCKET SET
Sizes: H6-H19

ACK-384022 — 1/2"



19pcs 1/2" IMPACT SOCKET SET
Sizes: 10-32mm

ACK-384023 — 1/2"



11pcs 1/2" DEEP IMPACT SOCKET SET
Sizes: 12-32mm

ASA-10001 — 1/2"



3pcs 1/2" DEEP IMPACT WHEEL NUT SOCKETS SET
Sizes: 17,19+21mm

ABS-80006



11pcs 10mm SPLINE POWER BIT SET
Sizes: M5-M12

ABS-80007



15pcs 10mm TORX POWER BIT SET
Sizes: T20-T55

ASA-40002 — 1/2"



8pcs 1/2" TORX IMPACT SOCKET SET
Sizes: T30-T80

ASA-40011 — 1/2"



13pcs 1/2" DEEP IMPACT SOCKET SET
Sizes: 10-30mm

ABS-12120 — 1/2"



9pcs 1/2" BIT SOCKET SETS
Sizes: H4-H17
Sizes: T20-T60

A504013 — 1/2"



13pcs 1/2" SPECIAL UNIVERSAL JOINT SOCKETS SET
Sizes: 10-19mm

ABS-12119 — 1/4"



14pcs 1/4" HEX + TORX BIT SOCKET SET
Sizes: T8-T40 + H3-H8

ABS-12117 — 1/4", 3/8", 1/2"



11pcs 1/4", 3/8"+1/2" E-TORX SOCKET SET
Sizes: E4-E20

ATF-5223 — 1/4 1/2



40pcs 1/2"+1/4" SPECIAL AUTOMOTIVE BIT SOCKET SET

LA-01677 — 1/2



14pcs 1/2" SPECIAL SOCKETS FOR DIESEL INJECTORS & OXYGEN SENSORS SET

ATF-5091 — 1"



5pcs 1" SPECIAL IMPACT SOCKETS FOR TRUCK WHEEL NUTS
Sizes: 33, 35, 38, 41, 1-1/2"

SIST-16PCS — 3/4 1"



16pcs 1"+3/4" SPECIAL IMPACT SOCKETS & BITS FOR TRUCK REPAIRS

B9156 — 3/4



6pcs 3/4" SPECIAL IMPACT SOCKETS SET FOR TRUCK REPAIRS
Sizes: 17, 19, E18, E20, E22, E24

B9153 — 1/2



8pcs 1/2" SPECIAL IMPACT SOCKETS & BITS SET FOR DRIVE SHAFTS NUTS
Sizes: 30, 32, 34, 35, 36 mm
H14, H17, H19

QK-1030H — 1/2 3/4



6pcs 1/2"+3/4" SPECIAL IMPACT TWIST SOCKETS SET
Sizes: 22, 24, 27, 32, 36, 41mm
Ideal for removing damage nuts

GL-0910



60pcs 10mm POWER BITS SET TORX, HEX, SPLINE, RIBE

ATF-5072 — 1/2



9pcs 1/2" SPECIAL IMPACT TWIST SOCKETS SET
Sizes: 10-19mm
Ideal for removing damage nuts

B1337 — 1/2



4pcs 1/2" SPECIAL IMPACT TWIST WHEEL SOCKETS SET
Sizes: 17-22mm
Ideal for removing damage nuts

B1344 — 1/2 3/4



13pcs 1/2"+1/4" SPECIAL IMPACT TWIST SOCKETS SET
Sizes: 6-27mm
Ideal for removing damage nuts

ATF-5140 — 1/2



7pcs 1/2" SPECIAL IMPACT LEFT HAND THREADED SOCKETS SET
Sizes: 17-26mm
Ideal for removing wheels lock nuts

ATF-5214A



6pcs IMPACT ADAPTOR SET

GG-2901 — 3/8



5pcs 3/8" UNIVERSAL JOINT E-TORX SOCKETS SET
Sizes: E8 - E16

GG-2937 SAE 1/2



10pcs 1/2" SAE SOCKETS SET
Sizes: 3/8" - 15/16"

A1016 — 1/4



7pcs 1/4" 5PT, TORX BIT SOCKETS SET
Sizes: T10-T40

A0032B



32pcs BITS & RATCHET SET

AWT-ERSK06



16pcs COMBINATION SPANNER SET
Sizes: 6-24mm

S2170



6pcs FLARE NUT COMBINATION WRENCH SET
Sizes: 8-17mm

S2202 $\frac{3}{8}$ "



10pcs $\frac{3}{8}$ " CROWFOOT WRENCH SET
Sizes: 10-19mm

AWT-35033-12



12" ADJUSTABLE ANGLE WRENCH

2BP-2009 $\frac{1}{2}$ " Hex Ball Point
2TX-2009 Torx Set
2TF-2009 Torx Tamper



LONG TYPE KEY WRENCH SETS

A3861 $\frac{1}{2}$ "



SPECIAL $\frac{1}{2}$ " SOCKET FOR BENZ PRE CHAMBER
Suitable eng.: 601, 602, 603, 604, 605, 606, 661, 662 (1986-1999)

LA1513-1 $\frac{1}{2}$ "



SPECIAL $\frac{1}{2}$ " T100 TAMBER BIT SOCKET FOR BENZ CAMSHAFT FRONT GEAR
Suitable eng.: M271

AUJ-P6115 $\frac{3}{4}$ "
AUJ-P4072 $\frac{1}{2}$ "



IMPACT UNIVERSAL JOINTS

ALH-A6500 $\frac{3}{4}$ "



$\frac{3}{4}$ " L-TYPE HANDLE BAR
L: 500mm

AST-B6500 $\frac{3}{4}$ "
S88623-1 $1\frac{1}{2}$ "



SLIDING T-HANDLE BARS
 $\frac{3}{4}$ " L: 500mm
 $1\frac{1}{2}$ " L: 550mm

RH-D85448 $\frac{1}{2}$ "



$\frac{1}{2}$ " 48T. EXTENDABLE RATCHET HANDLE

EB-0406 $\frac{1}{2}$ "



$\frac{1}{2}$ " WOBBLE EXTENSION BAR L: 600mm

LA-13099 $\frac{3}{8}$ "



8pcs $\frac{3}{8}$ " UNIVERSAL JOINT SOCKET SET
Sizes: 10-19mm

AS-082 $\frac{1}{2}$ "



5pcs $\frac{1}{2}$ " WHEEL IMPACT SOCKETS SET
Sizes: 17-24mm

AS-083 $\frac{1}{2}$ "



5pcs $\frac{1}{2}$ " WHEEL DEEP IMPACT SOCKETS SET
Sizes: 17-24mm

A1141 $\frac{1}{2}$ "



$\frac{1}{2}$ " 41mm SPECIAL DEEP IMPACT SOCKET FOR PEUGEOT & CITROEN WHEEL BEARING BOLTS
Suitable models: Peugeot 307 and Citroen C4

YF-62385 $\frac{1}{2}$ "



$\frac{1}{2}$ " 22mm EXTRA LONG OXYGEN SENSOR
Specifically for removing and installing the deep seated Lambda sensors
Suitable models: BENZ C & E Class, VAG, BMW, Ford, Vauxhall / Opel, Volvo & Rover



PROFESSIONAL GARAGE EQUIPMENT

LA-71001L HYDRAULIC BODY REPAIR KIT



Key Features:

- ▲ Ideal kit for autobody repair shops
- ▲ Relief valve to prevent over load



LA-71001B1 HYDRAULIC HAND PUMP



Key Features:

- ▲ Stainless steel pressure gauge
- ▲ Relief valve to prevent over load



LA-1210 HYDRAULIC PULL-BACK RAM



Key Features:

- ▲ Ideal for autobody repair shops
- ▲ Suitable for use with manual or air hydraulic pump



LA-3401 HYDRAULIC AIR FOOT PUMP



Key Features:

- ▲ Operating up to 690 bar
- ▲ Used with a variety of rams, press and hydraulic tools



D4531-1 HYDRAULIC HAND PUMP



Key Features:

- ▲ Dual piston hand pump
- ▲ Relief valve to prevent over load



BSD1101-36 HYDRAULIC CYLINDER KIT



Key Features:

- ▲ Heavy duty hydraulic spindle
- ▲ Ideal kit for removing bush and bearings
- ▲ Suitable for use with manual or air hydraulic pump

LA-1002 PROFESSIONAL WORKBENCH WITH OIL DRAIN CYCLE

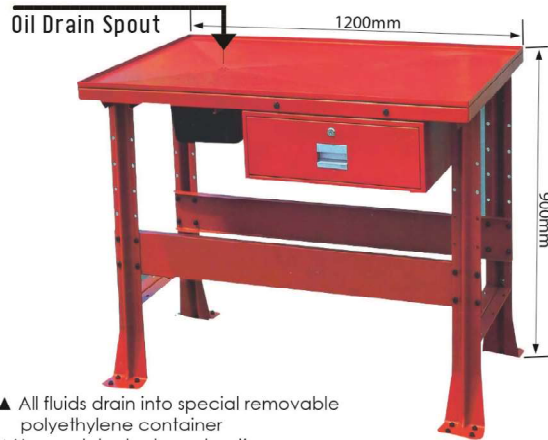

- ▲ All fluids drain into special removable polyethylene container
- ▲ Heavy duty steel construction
- ▲ Lockable drawer with ball bearings
- ▲ Includes 4 wheels

LA-1252 ENGINE STAND



- ▲ Rotates 360 degrees
- ▲ Wide base frame with 4 wheels for extra movement
- ▲ Can be locked in 8 different positions
- ▲ Includes a parts storage tray
- ▲ Heavy duty steel construction

CES-418 GEARBOX & ENGINE SUPPORT



- Key Features:**
- ▲ Heavy duty steel construction
 - ▲ Special new design with 4 fixing point to be bridge to support the engine
 - ▲ N.W.: 36kg

LA-50001 GEARBOX & ENGINE SUPPORT



- Key Features:**
- ▲ Heavy duty steel construction
 - ▲ N.W.: 22kg

LA-7508 TRIPLE FOLDING RAMP

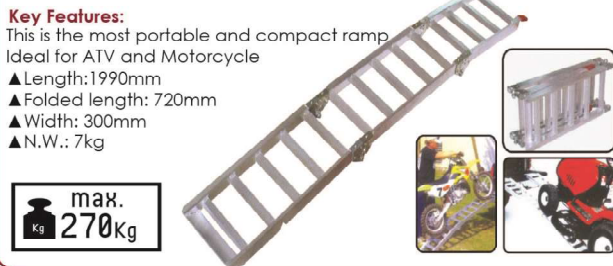

- Key Features:**
- This is the most portable and compact ramp
Ideal for ATV and Motorcycle
- ▲ Length: 1990mm
 - ▲ Folded length: 720mm
 - ▲ Width: 300mm
 - ▲ N.W.: 7kg

LA-3001 ALUMINUM FOLDING WORK STEP



- Key Features:**
- ▲ Work Top Size: 956 x 305mm
 - ▲ High: 500mm
 - ▲ N.W.: 8.2kg

LA-20809 HYDRAULIC BOTTLE JACK 

LA-20814 HYDRAULIC BOTTLE JACK 

- Key Features:**
- ▲ Manual pressure pump for heavy unit loads



LA-20858 JACK STAND PAIR 

LA-20860 JACK STAND PAIR 

- Key Features:**
- ▲ Self locking mechanism
 - ▲ High Reliability



LA-830018 LOW PROFILE TROLLEY JACK

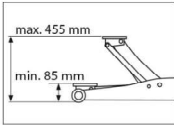
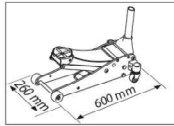

- Key Features:**
- ▲ Low profile
 - ▲ Relief valve to prevent over load

LA-83508 LOW PROFILE TROLLEY JACK

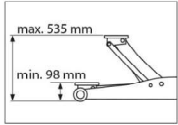
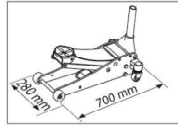

- Key Features:**
- ▲ Low profile
 - ▲ Robust design
 - ▲ Relief valve to prevent over load

LA-820031 LOW PROFILE TROLLEY JACK

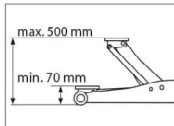
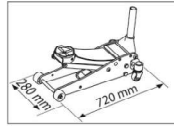

- Key Features:**
- ▲ Low profile
 - ▲ Robust design
 - ▲ Foot pedal for quick lifting
 - ▲ Relief valve to prevent over load

LA-830028 LONG FRAME TROLLEY JACK

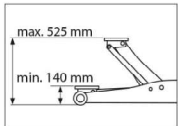
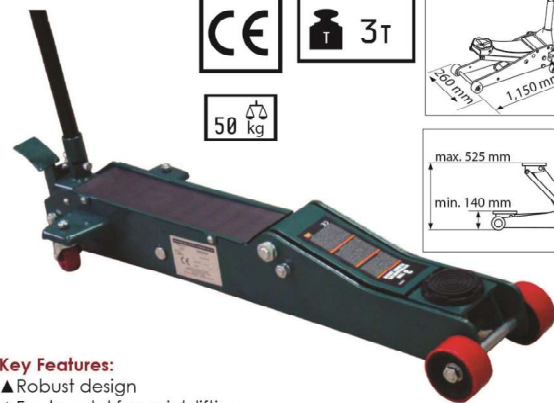
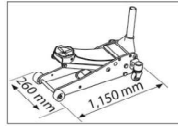

- Key Features:**
- ▲ Robust design
 - ▲ Foot pedal for quick lifting
 - ▲ Relief valve to prevent over load
 - ▲ Nylon wheels for floor protection
 - ▲ Slowly down with loading, more safety

LA-50000 HEAVY DUTY LONG FRAME JACK

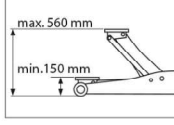
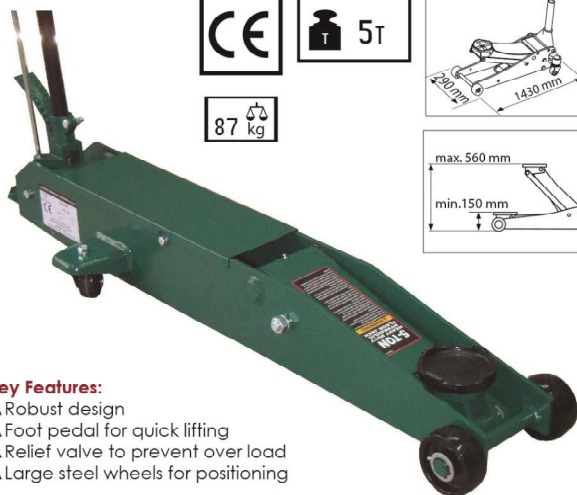
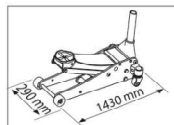

- Key Features:**
- ▲ Robust design
 - ▲ Foot pedal for quick lifting
 - ▲ Relief valve to prevent over load
 - ▲ Large steel wheels for positioning

LA-10001 HEAVY DUTY LONG FRAME JACK

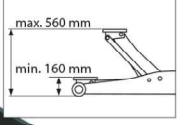
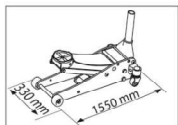

- Key Features:**
- ▲ Robust design
 - ▲ Foot pedal for quick lifting
 - ▲ Relief valve to prevent over load
 - ▲ Large steel wheels for positioning

LA-E03012 PROFESSIONAL FOLDING CRANE



Key Features:

- ▲ Strong steel frame construction
- ▲ Lifting range: 300mm-2040mm



LA-E05012 HEAVY DUTY PROFESSIONAL FOLDING CRANE



Key Features:

- ▲ Strong steel frame construction
- ▲ Lifting range: 245mm-1950mm
- ▲ Nylon wheels for floor protection



LA-6675 MOTORCYCLE AND ATV MOTORBIKE LIFT



Key Features:

- ▲ Strong steel frame construction
- ▲ Mechanical safety locking system
- ▲ Lifting range: 140mm-420mm



LA-0605 TRANSMISSION LIFT WITH SPECIAL CLAMP SADDLE



Key Features:

- ▲ Two-stage telescopic cylinder ram provides high raise
- ▲ Wide base with four swivel ball bearing caster nylon wheels provides stability and easy maneuvering
- ▲ Heavy duty steel construction
- ▲ Lifting range: 815mm-1760mm
- ▲ Fast lifting



LA-31002CE PROFESSIONAL FOLDING CRANE



Key Features:

- ▲ Strong steel frame construction
- ▲ Lifting range: 300mm-2080mm
- ▲ Nylon wheels for floor protection
- ▲ Low profile



LA-06011 HEAVY DUTY TRANSMISSION LIFT



Key Features:

- ▲ Strong steel frame construction
- ▲ Lifting range: 1210mm-2040mm
- ▲ Nylon wheels for floor protection



LA-12001 BENCH HYDRAULIC PRESS

max force
12T

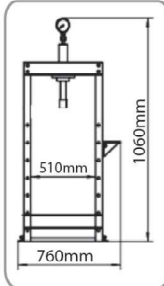

- Key Features:**
- ▲ Strong steel frame construction
 - ▲ Stainless steel pressure gauge
 - ▲ Relief valve to prevent overload

LA-20001 COLUMN HYDRAULIC PRESS

max force
20T

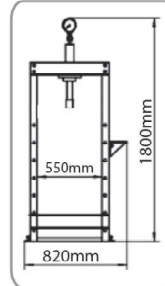

- Key Features:**
- ▲ Strong steel frame construction
 - ▲ Stainless steel pressure gauge
 - ▲ Relief valve to prevent overload



LA-20021 COLUMN HYDRAULIC PRESS

max force
20T

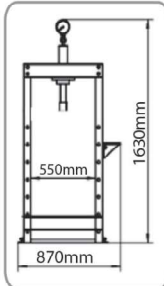

- Key Features:**
- ▲ Strong steel frame
 - ▲ Stainless steel pressure gauge
 - ▲ Relief valve to prevent overload



Ball Bearing Move

LA-30002 COLUMN HYDRAULIC PRESS

max force
30T

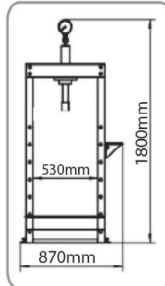

- Key Features:**
- ▲ Strong steel frame construction
 - ▲ Stainless steel pressure gauge
 - ▲ Relief valve to prevent overload



LA-P01102A BENCH HYDRAULIC PRESS

max force
10T

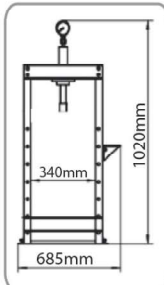

- Key Features:**
- ▲ Strong steel frame construction
 - ▲ Relief valve to prevent overload

LA-P01401 COLUMN HYDRAULIC PRESS

max force
40T

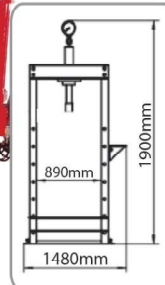

- Key Features:**
- ▲ Strong steel frame construction
 - ▲ Stainless steel pressure gauge
 - ▲ Relief valve to prevent overload



LA-326 8 DRAWER ROLLER CABINET



Key Features:

- ▲ With smooth and full-opened ball bearing slides.
- ▲ With recessed and perforated side panel for hanging some tools
- ▲ With inner lock system to keep much safer.
- ▲ With 5" ball bearing casters, two fixed and two swivel with brakes.
- ▲ With 10 pcs metal hooks

LA-327 TROLLEY WITH 3 SHELF AND BOARD

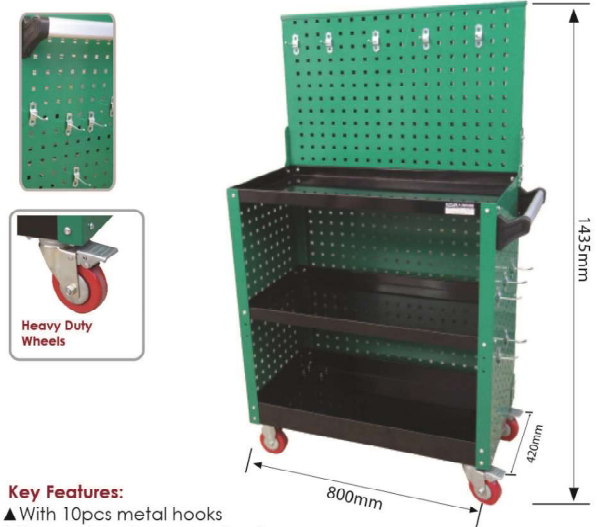

Key Features:

- ▲ With 10pcs metal hooks
- ▲ Heavy duty strong construction
- ▲ With 3" ball bearing casters, two fixed and two swivel with brakes.

LA-328 TROLLEY WITH 3 SHELF BIG



Key Features:

- ▲ Heavy duty strong construction
- ▲ With 3" ball bearing casters, two fixed and two swivel with brakes
- ▲ With 10 pcs metal hook

LA-329 TROLLEY WITH 3 SHELF



Tool storage rack

LA-6100 AUTO GARAGE SHORT CREEPER SEAT



Key Features:

- ▲ Strong steel construction
- ▲ Weight: 4.1 kg

LA-6455 AUTO GARAGE CREEPER

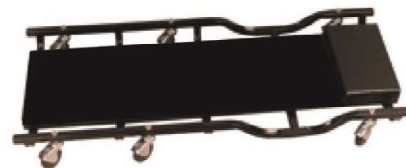

Key Features:

- ▲ Strong steel construction
- ▲ Weight: 5.6 kg

K3594



AUTO TRANSMISSION OIL FILLER PUMP 7.5L.
Includes set of adaptors

H3734



PROFESSIONAL AIR CLEANING KIT

S6137 Internal plier
S6139 External plier



CIRCLIPS PLIERS
L: 310mm

ATS-4023B



16L OIL DRAINAGE PAN
Resistant to most solvents.

H3701 L: 100mm
H3707 L: 250mm



BLOW-OUT GUNS FOR COMPRESSED AIR

A0620



2pcs BRASS PUNCHES
Sizes: 200 & 250mm

ST-24567



FLUID SIPHON HAND PUMP
Ideal for pumping fuel into the engine diesel system

A7623



3L WHEEL OIL DRAIN PAN FOR TRUCK AND BUSES

K3123-13mm 13pcs kit
K3123-15mm 13pcs kit
K3123-17mm 13pcs kit



OIL DRAIN PLUG THREAD REPAIR KITS

TH-2660



64pcs OIL DRAIN PLUG THREAD REPAIR KIT
M13, M15, M17, M20

TH-2661



96pcs OIL DRAIN PLUG THREAD REPAIR KIT
M13, M15, M17, M20, M22

LA-05039



10L METAL OIL DRAIN PAN

S3305



IMPACT SCREWDRIVER SET

ATG-5103B05

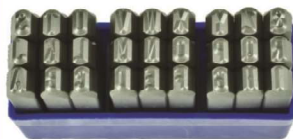

27pcs GERMAN ALPHABET STEEL STAMPS 5mm (A to Z)

ATG-5103A05



9pcs GERMAN NUMBER STEEL STAMPS 5mm (0 to 8)

LA-01295 790x580mm
LA-08214 900x610mm



MAGNETIC WORKSHOP WING COVER

A9000



**131pcs THREAD REPAIR KIT
M5,M6,M8,M10,M12**
Creates a stronger internal
thread in soft metals

A9009



**32pcs THREAD INSERTS WITH
CUTTING SLOTS REPAIR KIT
M5, M6, M8, M10**
Creates a stronger internal
thread in soft metals

E2201



**40pcs TAP & DIES SET
M3-M12**
Made of alloy steel

ATF-5123



**6pcs 3/8" RATCHETING TAP
AND DIE TOOL SET**

A9000-M6-25P



**24pcs THREAD REPAIR KIT
M6x1.0x8mm**
Creates a stronger internal
thread in soft metals

A0225C



**FLEXIBLE HOSE CLAMP WITH
AUTOMATIC CLAMPING
DEVICE**
Especially suitable for BENZ
new models

A2112



FLEXIBLE HOSE CLAMP
Especially suitable for
difficult to reach areas

LA-01509



**BEARING AND BUSH DRIVER
SET** For assembly of bearings,
seals and rubbers
Particularly useful
with hydraulic presses

ATM-0049



HOSE CLAMP PLIER

A0956E



HOSE CLAMP PLIER FOR
CLIC-CLIC CLAMPS

A1118



**MULTI-DIRECTIONS HOSE
CLAMP PLIER**
Especially suitable for VAG
fuel line clamps

A2506



FLUID LINE CLAMP PLIER
With automatic clamping
device

YF-62148



FUEL LINE CONNECTOR PLIER
Especially suitable for
OPEL, RENAULT, FIAT

KA-3979



EXHAUST PIPE CLAMPS PLIER
Especially suitable for
PEUGEOT, CITROEN

A0086



**SMALL HOSE CLAMP VISE
TOOL**
Especially suitable for
difficult to reach areas

GG-0506

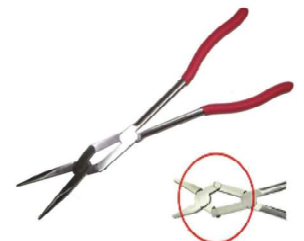

**EXTRA LONG NOSE
PLIER 45 DEGREE**

ACK-384020



7pcs PUNCH & CHISEL SET

ACK-384021



11pcs PUNCH & CHISEL SET

KA-2304K



16pcs PUNCH & CHISEL SET

APH-10002



6pcs PUNCH SET
Sizes: 2, 3, 4, 5, 6, 8mm

ATH-7026



4pcs NUT SPLITTER SET
For the mechanical splitting of faulty or over wound nuts

D1025A



9pcs SPECIAL TOOL SET FOR DOOR HINGE BOLTS
Ideal set for auto body shops

E2061



3pcs STAINLESS STEEL SCRAPER KNIFE SET
Sizes: 15, 20, 30mm

E2188



4pcs STUD PULLER SET
Sizes: 6, 8, 10, 12mm

A8679



FUEL TANK SENDER SPANNER SET
Especially suitable for BENZ W202, W203, W209, W210, W211 & BMW E36, E46

XR-1118



FUEL TANK SENDER SPANNER TOOL FOR EUROPEAN VEHICLES
Universal applications

LA-01839



FUEL TANK SENDER SPANNER TOOL
Adjustable and universal usage

LA-01739



FUEL TANK SENDER SPANNER TOOL
Especially suitable for BENZ W164 & W251

A624750



FUEL TANK SENDER SPANNER TOOL
Especially suitable for BENZ W204 & W212

A11-K119



UNIVERSAL LOCK OUT TOOL SET

ATG-6251



AIR INFLATE FOR UNLOCK DOORS
Size: 200 x 150mm

HR-67003



EFFORTLESS INDUSTRIAL HAND RIVETER
Sizes: 3.2, 4.0, 4.8, & 6.4mm

S3270



6pcs DOOR UPHOLSTERY REMOVER TOOL SET

E2186



STUD REMOVER TOOL
Size: 5-19mm

KA-5077K



5pcs TRIM PIN REMOVERS
Stainless steel with 2-component plastic handles
Ideal set for auto body shops

LA-01114



11pcs HANDY REMOVAL SET FOR DASHBOARD
Various levers made of glass-fibre reinforced plastic

ATG-6144



4pcs PROFESSIONAL PRY BAR SET
Sizes: 20, 30, 45, 60cm

S3308



HEAVY DUTY PRY BAR
Length: 90cm

ATR-3075 S4K1



4pcs TIRE CHANGING LEVER TOOL SET
Sizes: 30, 40, 50, 60cm

ASD-168K03



6pcs PRECISION MINI SCREWDRIVER SET

ATN-1005



LIGHTED ROUND MAGNETIC MIRROR

**E2056
E2060**

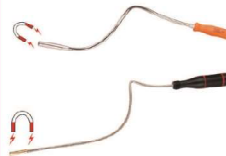

FLEXIBLE MAGNETIC PICK UP TOOLS

LA-13147D



7pcs TORX TAMPERPROOF SCREWDRIVER
Sizes: TX10-TX40

GE-238



265pcs METRIC SIZE O'RINGS SET

E2005



120pcs AUTOMOTIVE PLASTIC CLIPS SET

E1402



500pcs COTTER PIN SET

**E2621 Ø 150mm
E2622 S.:240x140mm**



MAGNETIC COLLECTION TRAYS

503311313



2 SIZES STEEL CRUMBLED WIRE BRUSHES WITH DRILL ARBOR 13 & 20mm
Ideal set for cleaning carbon from diesel injector shaft hole
Length: 200mm
Made in Germany

5603101520



3 SIZES STEEL WIRE HOLE BRUSHES WITH WOODEN HANDLE 10,15 & 20mm
Ideal set for cleaning carbon from diesel injector shaft hole
Length: 300mm
Made in Germany

5423020304



3 SIZES STEEL WIRE HOLE BRUSHES WITH LOOP 5,7 & 8mm Ideal set for cleaning carbon from glow plug shaft hole
Length: 300mm
Made in Germany

ATG-6108



4pcs STAINLESS STEEL MINI HOOK AND PICK SET

A2512



2pcs HOSE REMOVER

RAACO 1248-01



Key Features:

- ▲ Dimensions H x W x D: 550 x 305 x 147mm
- ▲ Robust steel cabinet with 48 drawers

RAACO 1240-123



Key Features:

- ▲ Dimensions H x W x D: 550 x 305 x 147mm
- ▲ Robust steel cabinet with 40 drawers

RAACO C10-40



Key Features:

- ▲ Dimensions H x W x D: 465 x 306 x 147mm
- ▲ Robust steel cabinet with 40 drawers

RAACO C9-18



Key Features:

- ▲ Dimensions H x W x D: 417 x 306 x 147mm
- ▲ Robust steel cabinet with 18 drawers

RAACO C8-30



Key Features:

- ▲ Dimensions H x W x D: 375 x 306 x 147mm
- ▲ Robust steel cabinet with 30 drawers

RAACO C7-24



Key Features:

- ▲ Dimensions H x W x D: 330 x 306 x 147mm
- ▲ Robust steel cabinet with 24 drawers

RAACO 4 x PSC



Key Features:

- ▲ Dimensions H x W x D: 310 x 376 x 265mm
- ▲ Complete portable carrying handy box.

RAACO 4-32



Key Features:

- ▲ Dimensions W x D: 340 x 250mm
- ▲ Profi service box with 32 fix compartments

RAACO 48 x 2-80 PANELS AND BINS SET



Key Features:

- ▲ Dimensions H x W x D: 440 x 1040 x 133mm
- ▲ Two perforated galvanized steel wall panel with 48 bins

RAACO 32 x 3-160 PANELS AND BINS SET



Key Features:

- ▲ Dimensions H x W x D: 440 x 1040 x 133mm
- ▲ Two perforated galvanized steel wall panels with 32 bins

RAACO 24 x 4-280 PANELS AND BINS SET



Key Features:

- ▲ Dimensions H x W x D: 440 x 1040 x 133mm
- ▲ Two perforated galvanized steel wall panel with 24 bins

RAACO 109659 WALL PANEL

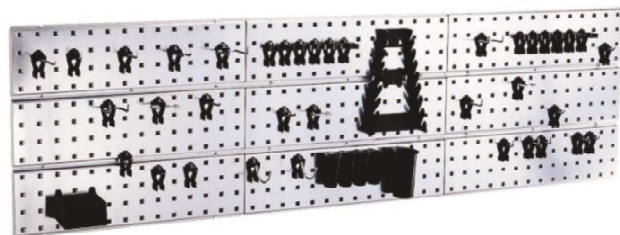

Key Features:

- ▲ Dimensions H x W: 1560 x 440mm
- ▲ Three perforated panels with 44 assorted super tools clips